



TURBO HD H1T Series Turret & Dome Camera

User Manual

UD05377B

User Manual

Thank you for purchasing our product. If there are any questions, or requests, do not hesitate to contact the dealer.

This manual applies to the models below:

Type	Model
Type I Camera	DS-2CE56H1T-IT1(E)
	DS-2CE56H1T-IT3(E)
Type II Camera	DS-2CE56H1T-ITM(E)
Type III Camera	DS-2CE56H1T-VPIT(E)

This manual may contain technical incorrect places or printing errors, and the content is subject to change without notice. The updates will be added to the new version of this manual. We will readily improve or update the products or procedures described in the manual.

Regulatory Information

FCC Information

Please take attention that changes or modification not expressly approved by the party responsible for compliance could void the user's authority to operate the equipment.

FCC compliance: This equipment has been tested and found to comply with the limits for a Class A digital device, pursuant to part 15 of the FCC Rules. These limits are designed to provide reasonable protection against harmful interference when the equipment is operated in a commercial environment. This equipment generates, uses, and can radiate radio frequency energy and, if not installed and used in accordance with the instruction manual, may cause harmful interference to radio communications. Operation of this equipment in a residential area is likely to cause harmful interference in which case the user will be required to correct the interference at his own expense.

FCC Conditions

This device complies with part 15 of the FCC Rules. Operation is subject to the following two conditions:

1. This device may not cause harmful interference.
2. This device must accept any interference received, including interference that may cause undesired operation.

EU Conformity Statement



This product and - if applicable - the supplied accessories too are marked with "CE" and comply therefore with the applicable harmonized European standards listed under the Low Voltage Directive 2014/35/EU, the EMC Directive 2014/30/EU.



2012/19/EU (WEEE directive): Products marked with this symbol cannot be disposed of as unsorted municipal waste in the European Union. For proper recycling, return this product to your local supplier upon the purchase of equivalent new equipment, or dispose of it at designated collection points. For more information see: www.recyclethis.info.



2006/66/EC (battery directive): This product contains a battery that cannot be disposed of as unsorted municipal waste in the European Union. See the product documentation for specific battery information. The battery is marked with this symbol, which may include lettering to indicate cadmium (Cd), lead (Pb), or mercury (Hg). For proper recycling, return the battery to your supplier or to a designated collection point. For more information see: www.recyclethis.info.

Industry Canada ICES-003 Compliance

This device meets the CAN ICES-3 (A)/NMB-3(A) standards requirements.

Safety Instruction

These instructions are intended to ensure that user can use the product correctly to avoid danger or property loss.

The precaution measure is divided into “Warnings” and “Cautions”.

Warnings: Serious injury or death may occur if any of the warnings are neglected.

Cautions: Injury or equipment damage may occur if any of the cautions are neglected.

	
Warnings Follow these safeguards to prevent serious injury or death.	Cautions Follow these precautions to prevent potential injury or material damage.



Warnings

- In the use of the device, you must be in strict compliance with the electrical safety regulations of the nation and region.
- Input voltage should meet both the SELV (Safety Extra Low Voltage) and the Limited Power Source with 12 VDC according to the IEC60950-1 standard. Refer to technical specifications for detailed information.
- Do not connect multiple devices to one power adapter to avoid over-heating or a fire hazard caused by overload.
- Make sure that the plug is firmly connected to the power socket.
- Make sure that the device is firmly fixed if wall mounting or ceiling mounting is adopted.
- If smoke, odor or noise rise from the device, turn off the power at once and unplug the power cord, and then contact the service center.
- Never attempt to disassemble the camera by unprofessional personal.



Cautions

- Do not drop the camera or subject it to physical shock.
- Do not touch sensor modules with fingers.
- If cleaning is necessary, use clean cloth with a bit of ethanol and wipe it gently.
- Do not aim the camera at the sun or extra bright places.
- The sensor may be burned out by a laser beam, so when any laser equipment is in using, make sure that the surface of sensor will not be exposed to the laser beam.
- Do not expose the device to high electromagnetic radiation or extremely hot, cold, dusty or damp environment.
- To avoid heat accumulation, good ventilation is required for the operating environment.
- Keep the camera away from liquid while in use for non-water-proof device.
- While in delivery, the camera shall be packed in its original packing, or packing of the same texture.

1 Introduction

1.1 Product Features

The camera is applicable for both indoor and outdoor conditions, and the application scenarios include road, warehouse, underground parking lot, bar, etc..

The main features are as follows:

- High performance CMOS sensor
- Low illumination, 0.01 Lux @ (F1.2, AGC ON), 0 Lux with IR
- IR cut filter with auto switch
- OSD menu with configurable parameters
- Auto white balance
- Internal synchronization
- SMART IR mode
- PoC (with -E)
- 3-axis adjustment

1.2 Overview

This manual applies to three types of turret cameras. The overviews of each type are shown in the figures below.

1.2.1 Overview of Type I Camera

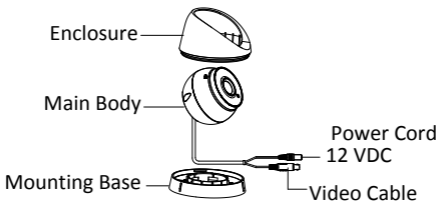

Figure 1-1 Overview of Type I Camera

1.2.2 Overview of Type II Camera

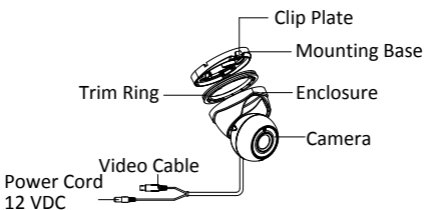

Figure 1-2 Overview of Type II Camera

1.2.3 Overview of Type III Camera

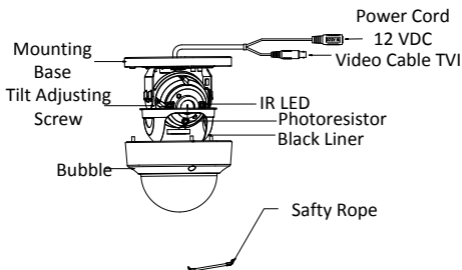

Figure 1-3 Overview of Type III Camera

2 Installation

Before you start:

- Make sure that the device in the package is in good condition and all the assembly parts are included.
- Make sure that all the related equipment is power-off during the installation.
- Check the specification of the products for the installation environment.
- Check whether the power supply is matched with your required output to avoid damage.
- Make sure the wall is strong enough to withstand three times the weight of the camera and the bracket.
- If the wall is cement, insert expansion screws before installing the camera. If the wall is wooden, use self-tapping screw to secure the camera.
- If the product does not work properly, contact your dealer or the nearest service center. Do NOT disassemble the camera for repair or maintenance by yourself.

2.1 Installation of Type I Camera

2.1.1 Ceiling/Wall Mounting without Junction Box

Steps:

1. Disassemble the turret camera by rotating the camera to align the notch to one of the marks, as shown in the figure below.

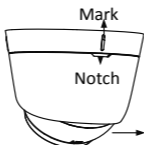

Figure 2-1 Disassemble the Camera

2. Remove the mounting base from the camera body with a flat object, e.g., a coin.
3. Paste the drill template (supplied) to the place where you want to install the camera.
4. Drill the screw holes and the cable hole (optional) on the ceiling/wall according to the drill template.

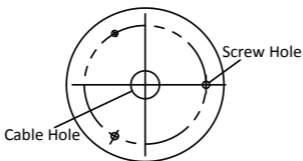

Figure 2-2 Drill Template

Note:

Drill the cable hole, when adopting the ceiling outlet to route the cable.

5. Attach the mounting base to the ceiling/wall, and secure them with supplied screws.

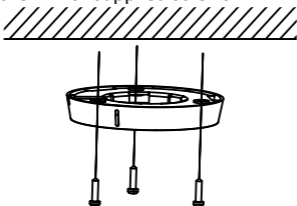

Figure 2-3 Attach the Mounting Base to the Ceiling

Note:

- The supplied screw package contains self-tapping screws, and expansion bolts.
- For cement wall/ceiling, expansion bolts are required to fix the camera. For wooden wall/ceiling, self-tapping screws are required.

6. Route the cables through the cable hole, or the side opening.
7. Align the camera with the mounting base, and tighten the screws to secure the camera on the mounting base.

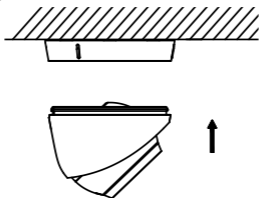

Figure 2-4 Secure the Camera with Mounting Base

8. Connect the corresponding cables, such as power cord, and video cable.
9. Power on the camera to check whether the image on the monitor is gotten from the optimum angle. If not, adjust the camera according to the figure below to get an optimum angle.

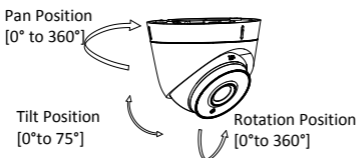

Figure 2-5 3-axis Adjustment

- 1). Hold the camera body and rotate the enclosure to adjust the pan position [0° to 360°].
- 2). Move the camera body up and down to adjust the tilt position [0° to 75°].

- 3). Rotate the camera body to adjust the rotation position [0° to 360°].

2.1.2 Mounting with Inclined Base

Steps:

1. Paste the drill template (supplied) to the place where you want to install the camera.
2. Drill screw holes, and the cable hole on the ceiling/wall according to the supplied drill template.

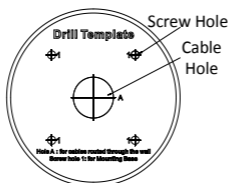

Figure 2-6 The Drill Template

3. Disassemble the inclined base by the screw driver.
4. Install the turret camera's mounting base on the inclined base cover with three PM4 screws.

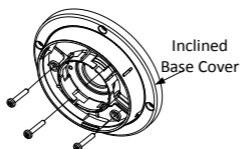

Figure 2-7 Install Turret Camera's Mounting Base

5. Install the inclined base's body on the ceiling/wall with four PA4 × 25 screws, as shown in Figure 2-8.

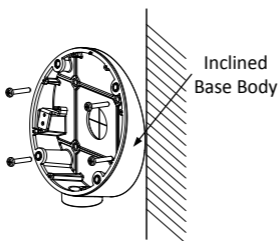

Figure 2-8 Fix the Inclined Base Body

6. Combine inclined base's cover with its body with supplied screws.
7. Repeat steps 6 to 9 of the 2.1.1 Ceiling/Wall Mounting without Junction Box to complete the installation.

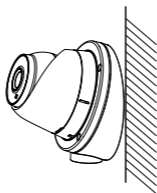

Figure 2-9 Fix the Camera to the Inclined Base

2.2 Installation of Type II Camera

Before you start:

Both wall mounting and ceiling mounting are suitable for the turret camera. Ceiling mounting will be taken as

an example in this section. You can take steps of ceiling mounting as the reference, when adopting the wall mounting.

Steps:

1. Disassemble the turret camera by rotating the camera to align the notch to the clip plate, as shown in the Figure 2-10.

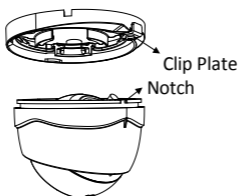

Figure 2-10 Disassemble the Camera

2. Pry the mounting base to remove the mounting base from the camera body.
3. Paste the drill template (supplied) to the place where you want to install the camera.
4. Drill the screw holes according to the drill template, and the cable hole (optional) on the ceiling.



Figure 2-11 Drill Template

Note:

Drill the cable hole in the center of the drill template, when adopting the ceiling outlet to route the cable.

5. Secure the mounting base to the ceiling with the supplied screws.

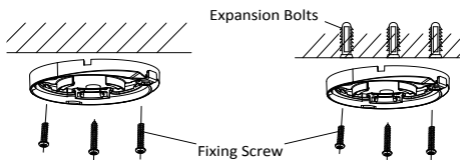

Figure 2-12 Fix the Mounting Base to the Ceiling

Note:

- The supplied screw package contains self-tapping screws, and expansion bolts.
 - For cement wall/ceiling, expansion bolts are required to fix the camera. For wooden wall/ceiling, self-tapping screws are required.
6. Route the cables through the cable hole, or the side opening.
 7. Secure the camera on the mounting base.

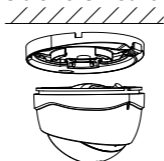

Figure 2-13 Secure the Camera

8. Connect the corresponding cables, such as power cord, and video cable.

- Power on the camera to check whether the image on the monitor is gotten from the optimum angle. If not, adjust the camera according to the figure below to get an optimum angle.

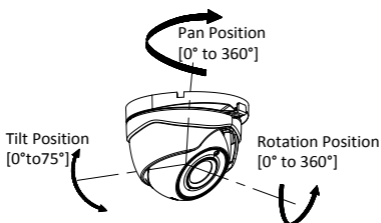

Figure 2-14 3-axis Adjustment

- Hold the camera body and rotate the enclosure to adjust the pan position [0° to 360°].
- Move the camera body up and down to adjust the tilt position [0° to 75°].
- Rotate the camera body to adjust the rotation position [0° to 360°].

2.3 Installation of Type I and Type II Camera

2.3.1 Ceiling/Wall Mounting with Junction Box

Steps:

- Paste the drill template on the ceiling/wall.
- Drill screw holes and the cable hole (optional) in the ceiling/wall according to the holes of the drill template.

Type I Camera

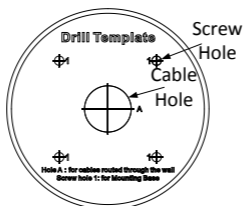

Type II Camera

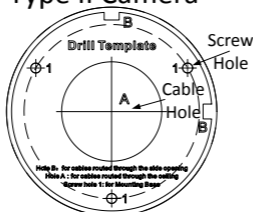

Figure 2-15 Drill Template of the Junction Box

Note:

Drill the cable hole, when adopting the ceiling outlet to route the cable.

- Take apart the junction box, and align the screw holes of the turret camera's mounting base with those on junction box's cover.
- Fix the mounting base on junction box's cover by supplied screws.

- Secure the junction box's body with supplied screws on the ceiling/wall.
- Combine the junction box's cover with the junction box's body.



Figure 2-16 Fix the Gang Box

- Repeat steps 6 to 9 of 2.1.1 *Ceiling/Wall Mounting without Junction Box* to install the camera to the junction box.

2.3.2 Wall Mounting

Before you start:

You need to purchase a wall mounting bracket separately.

Steps:

- Drill four screw holes in the wall according to the holes of the bracket.
- Install the bracket to the wall by aligning the four screw holes of the bracket with expansion screws on the wall.
- Secure the bracket with four hex nuts and washers.

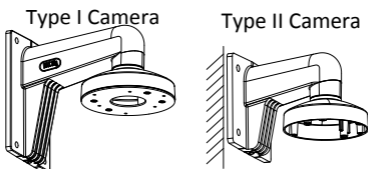

Figure 2-17 Install the Bracket

- Install the mounting base of the turret camera to the wall mounting bracket, and secure them with supplied screws.

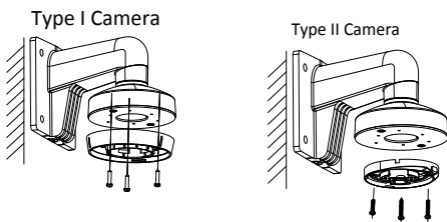

Figure 2-18 Install the Mounting Base to the Bracket

- Route the cables through the bracket.
- Repeat steps 7 to 9 of 2.1.1 *Ceiling/Wall Mounting without Junction Box* to complete the installation.

2.4 Ceiling Mounting of Type III Camera

Steps:

- Paste the drill template to the ceiling.
- Drill the screw holes and cable hole (optional) in the ceiling according to the drill template.

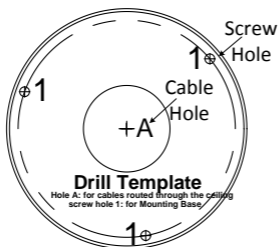

Figure 2-19 Drill Template

Note:

Cable hole is required, when adopting the ceiling outlet to route cables.

- Loosen the set screws with a hex wrench (supplied) to remove the bubble.

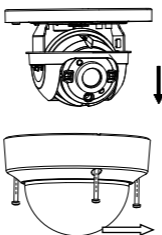

Figure 2-20 Remove the Bubble

- Fix the mounting base on the ceiling with supplied screws.

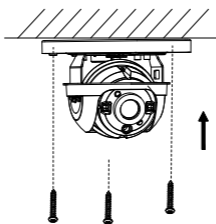

Figure 2-21 Fix the Mounting Base

- Route the cables through the cable hole, or the side opening.
- Connect the corresponding cables, such as power cord, and network cable.
- Power on the camera to check whether the image on the monitor is gotten from the optimum angle. If not, adjust the camera according to the figure below to get an optimum angle

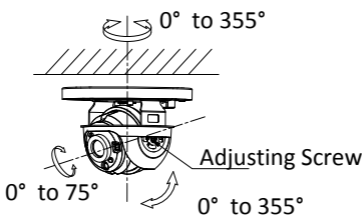

Figure 2-22 Type I Camera 2-Axis Adjustment

- Loosen the tilt adjusting screw to adjust the tilt position [0° to 75°].

- 2). Hold the black liner to adjust the pan position [0° to 355°].
- 3). Hold the camera body to adjust the rotation position [0° to 355°].
8. Reinstall the bubble, and tighten the screws.

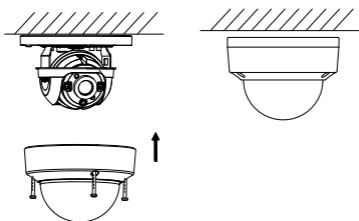



Figure 2-23 Bubble Reinstallation

3 Menu Description

Purpose:

Call the menu by clicking the button  on the PTZ Control interface, or call preset No.95.

Steps:

1. Connect the camera with the TVI DVR, and the monitor, shown as the figure 3-1.

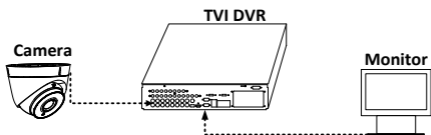



Figure 3-1 Connection

2. Power on the analog camera, TVI DVR, and the monitor to view the image on the monitor.
3. Click PTZ Control to enter the PTZ Control interface.
4. Call the camera menu by clicking  button, or call preset No. 95.

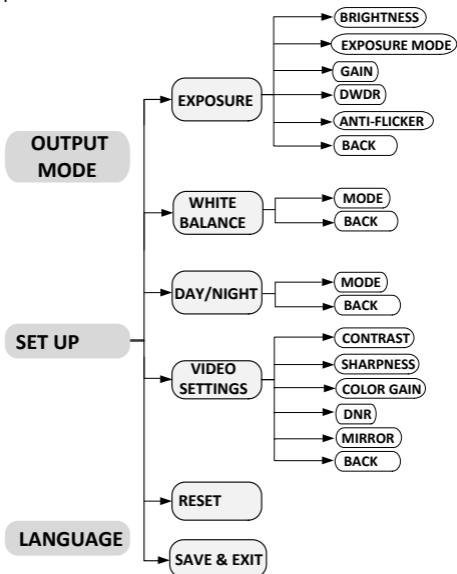

Figure 3-2 Main Menu Overview

5. Click the direction arrow to control the camera.
 - 1). Click up/down direction button to select the item.
 - 2). Click Iris + to confirm the selection.
 - 3). Click left/right direction button to adjust the value of the selected item.

3.1 OUTPUT MODE

In the OUTPUT MODE submenu, you can set RESOLUTION, FRAME RATE, and NTSC/PAL.

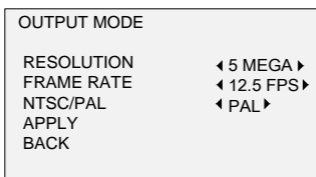

Figure 3-3 OUTPUT MODE

RESOLUTION

Resolution refers to the number of the pixels contained in an image. You can set the resolution as 5 megapixels, 4 megapixels or 1080p. The higher the value, the finer the image is.

FRAME RATE

Frame rate refers to the number of image output in 1 second.

When the resolution is set as 5 megapixels, you are allowed to set the frame rate as 20 fps or 12.5 fps. When the resolution is set as 4 megapixels, you are allowed to set the frame rate as 25 fps or 30 fps.

NTSC/PAL

PAL

(Phase Alternating Lines) is a color encoding system for analog television used in broadcast television systems in most countries.

NTSC

(National Television System Committee) is the analog television system that is used in most of North America, parts of South America, Myanmar, South Korea, etc.

Note:

NTSC/PAL is only available under the mode of 5 MEGA@12.5fps.

3.2 LANGUAGE

Supports English, and Chinese.

3.3 EXPOSURE

Exposure describes the brightness-related parameters, which can be adjusted by **BRIGHTNESS**, **EXPOSURE MODE**, **GAIN**, **DWDR** and **ANTI-FLICKER**.

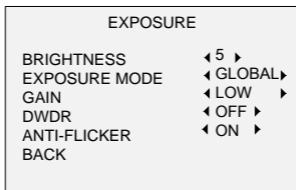

Figure 3-4 EXPOSURE

BRIGHTNESS

Brightness refers to the brightness of the image.

You can set the brightness value from 1 to 10 to darken or brighten the image. The higher the value, the brighter the image is.

EXPOSURE MODE

You can set the **EXPOSURE MODE** as **GLOBAL**, or **BLC**.

● GLOBAL

GLOBAL refers to the normal exposure mode which performs exposure according to the whole image brightness.

● BLC (Backlight Compensation)

BLC (Backlight Compensation) compensates light for the front object to make it clear, but this may cause the over-exposure of the background, where the light is strong.

When **BLC** is selected as the exposure mode, the **BLC** level can be adjusted from 0 to 8.

GAIN

It optimizes the clarity of the image in poor light conditions. The **GAIN** level can be set as **HIGH**, **MEDIUM**, or **LOW**. Select **OFF** to disable the **GAIN** function.

Note:

The noise will be amplified, when the **GAIN** is on.

DWDR (Digital Wide Dynamic Range)

The **DWDR** helps the camera provide clear images even under backlight circumstances. When both very bright and very dark areas simultaneously exist in the image, **DWDR** balances the brightness level of the whole image to provide clear images with details.

Set the **DWDR** as **ON** to improve the image quality under the backlight environment.

Set the **DWDR** as **OFF** to disable the function.

ANTI-FLICKER

Set the **ANTI-FLICKER** as **ON** to prevent the image from flicker.

3.4 WHITE BALANCE

White balance, the white rendition function of the camera, is to adjust the color temperature according to the environment. It can remove unrealistic color casts in the image. You can set **WB** mode as **ATW**, or **MWB**.

ATW (Auto Tracking White Balance)

Under **ATW** mode, white balance is being adjusted automatically according to the color temperature of the scene illumination.

MWB (Manual White Balance)

You can set the **R GAIN/B GAIN** value from 1 to 255 to adjust the shades of red/blue color of the image.

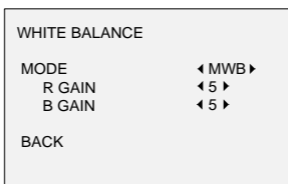

Figure 3-5 MWB MODE

3.5 DAY/NIGHT

COLOR, **BW** (Black White), and **AUTO** are selectable for **DAY/NIGHT** switch.

COLOR

The image is colored in day mode all the time.

B/W

The image is black and white all the time, and the IR LED turns on in the poor light conditions.

AUTO

Automatically switch Color or BW (Black and White) according to actual scene brightness

You can turn on/off the **INFRARED** and set the value of **SMART IR** in this menu.

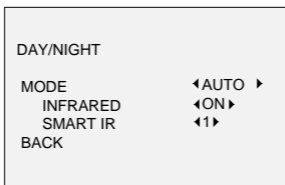

Figure 3-6 DAY NIGHT

● INFRARED

You can turn on/off the IR LED to meet the requirements of different circumstances.

● SMART IR

The **Smart IR** function is used to adjust the light to its most suitable intensity, and prevent the image from over exposure. The **SMART IR** value can be adjusted from 1 to 3. The higher the value, the more obvious effects are.

3.6 VIDEO SETTINGS

Move the cursor to **VIDEO SETTINGS** and click Iris+ to enter the submenu. **CONTRAST**, **SHARPNESS**, **COLOR GAIN**, **DNR**, and **MIRROR** are adjustable.

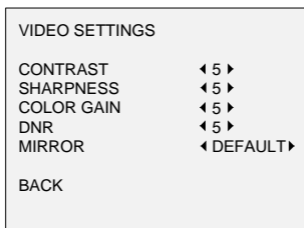

Figure 3-7 VIDEO SETTING

CONTRAST

This feature enhances the difference in color and light between parts of an image. You can set the **CONTRAST** value from 1 to 10.

SHARPNESS

Sharpness determines the amount of detail an imaging system can reproduce. You can set the **SHARPNESS** value from 1 to 10.

COLOR GAIN

Adjust this feature to change the saturation of the color. The value ranges from 1 to 10.

DNR (Digital Noise Reduction)

The DNR function can decrease the noise effect, especially when capturing moving images in low light

conditions and delivering more accurate and sharp image quality. You can set the **DNR** value from 1 to 10.

MIRROR

DEFAULT, **H**, **V**, and **HV** are selectable for mirror.

DEFAULT: The mirror function is disabled.

H: The image flips 180° horizontally.

V: The image flips 180° vertically.

HV: The image flips 180° both horizontally and vertically.

3.7 RESET

Reset all the settings to the default.

3.8 SAVE & EXIT

Move the cursor to **SAVE & EXIT** and click Iris+ to save the setting and exit the menu.