

DS-2DE4A425IWG-E 4 MP 25 × Network IR PTZ Camera



Hikvision DS-2DE4A425IWG-E 4 MP Network IR PTZ Camera adopts 1/2.8" progressive scan CMOS chip. With the 25 × optical zoom lens, the camera offers more details over expansive areas. This series of cameras can be widely used for wide ranges of high-definition, such as the rivers, forests, roads, railways, airports, ports, squares, parks, scenic spots, stations and large venues, etc.

- High quality imaging with 4 MP resolution, up to 60 fps
- Excellent low-light performance via powered-by-DarkFighter technology
- Clear imaging against strong back lighting due to 120 dB WDR technology
- Pan and tilt ability enables camera to monitor zones of interest
- 25 × optical zoom allows for closer viewing of subjects in expansive areas
- Up to 50 m IR range ensures safety at night
- Water and dust resistant (IP66)
- Focuses on human and vehicle targets classification based on deep learning

▪ DORI

The DORI (detect, observe, recognize, identify) distance gives the general idea of the camera ability to distinguish persons or objects within its field of view.

It is calculated based on the camera sensor specification and the criteria given by EN 62676-4: 2015.

DORI	Detect	Observe	Recognize	Identify
Definition	25 px/m	63 px/m	125 px/m	250 px/m
Distance (Tele)	2200 m (7217.8 ft)	873 m (2864.2 ft)	440 m (1443.6 ft)	220 m (721.8 ft)

▪ Specification

Camera	
Image Sensor	1/2.8" Progressive Scan CMOS
Max. Resolution	2560 × 1440
Min. Illumination	Color: 0.005 Lux @ (F1.6, AGC ON), B/W: 0.001 Lux @ (F1.6, AGC ON), 0 Lux with IR
Shutter Speed	1/1 s to 1/30,000 s
Day & Night	IR cut filter
Zoom	25 × optical, 16 × digital
Slow Shutter	Yes
Lens	
Focal Length	4.8 to 120 mm
FOV	Horizontal FOV 53.3° to 2.6°, vertical FOV 30.6° to 1.5°, diagonal FOV 60.5° to 3°
Focus	Auto, semi-auto, manual
Aperture	Max. F1.6
Zoom Speed	Approx. 3.4 s
Illuminator	
Supplement Light Type	IR
Supplement Light Range	IR Distance: up to 50 m
Smart Supplement Light	Yes
IR Wavelength	850 nm
PTZ	
Movement Range (Pan)	0° to 360°
Movement Range (Tilt)	-5° to 90°
Pan Speed	Pan speed: configurable from 0.1° to 300°/s; preset speed: 350°/s
Tilt Speed	Tilt speed: configurable from 0.1° to 160°/s, preset speed 200°/s
Proportional Zoom	Yes
Presets	300
Preset Freezing	Yes
Patrol Scan	8 patrols, up to 32 presets for each patrol
Pattern Scan	4 pattern scans, record time over 10 minutes for each scan
Park Action	Preset, pattern scan, patrol scan, auto scan, tilt scan, random scan, frame scan, panorama scan
3D Positioning	Yes
PTZ Status Display	Yes
Scheduled Task	preset, pattern scan, patrol scan, auto scan, tilt scan, random scan, frame scan, panorama scan, dome reboot, dome adjust

Power-off Memory	Yes
Video	
Main Stream	50 Hz: 25 fps (2560 × 1440, 1920 × 1080, 1280 × 960, 1280 × 720) 60 Hz: 30 fps (2560 × 1440, 1920 × 1080, 1280 × 960, 1280 × 720)
Sub-Stream	50 Hz: 25 fps (704 × 576, 640 × 480, 352 × 288); 60 Hz: 30 fps (704 × 480, 640 × 480, 352 × 240)
Third Stream	50 Hz: 25 fps (1920 × 1080, 1280 × 960, 1280 × 720, 704 × 576, 640 × 480, 352 × 288); 60 Hz: 30 fps (1920 × 1080, 1280 × 960, 1280 × 720, 704 × 480, 640 × 480, 352 × 240)
Video Compression	Main stream: H.265+/H.265/H.264+/H.264 Sub-stream: H.265/H.264/MJPEG Third stream: H.265/H.264/MJPEG
H.264 Type	Baseline Profile/Main Profile/High Profile
H.265 Type	Main profile
Scalable Video Coding (SVC)	H.264 and H.265 encoding
Region of Interest (ROI)	8 fixed regions for each stream
Audio	
Audio Compression	G.711alaw/G.711ulaw/G.722.1/G.726/MP2L2/PCM/AAC-LC
Audio Bit rate	64 Kbps (G.711)/16 Kbps (G.722.1)/16 Kbps (G.726)/32 to 192 Kbps (MP2L2)/32 Kbps (PCM)/16 to 64 Kbps (AAC-LC)
Audio Sampling Rate	AAC-LC: 16 kHz, 32 kHz, 48 kHz; MP2L2: 16 kHz, 32 kHz, 48 kHz; PCM: 8 kHz, 16 kHz, 32 kHz, 64 kHz
Environment Noise Filtering	Yes
Network	
Protocols	IPv4/IPv6, HTTP, HTTPS, 802.1x, Qos, FTP, SMTP, UPnP, SNMP, DNS, DDNS, NTP, RTSP, RTCP, RTP, TCP/IP, UDP, IGMP, ICMP, DHCP, PPPoE, Bonjour, WebSocket, WebSockets
Simultaneous Live View	Up to 20 channels
API	Open Network Video Interface (Version 18.12), Profile S, Profile G, Profile T), ISAPI, SDK, ISUP
User/Host	Up to 32 users; 3 user levels: administrator, operator, and user
Security	Password protection, complicated password, HTTPS encryption, 802.1X authentication (EAP-TLS, EAP-LEAP, EAP-MD5), watermark, IP address filter, basic and digest authentication for HTTP/HTTPS, control timeout settings, security audit log, TLS 1.2, host authentication (MAC address)
Network Storage	NAS (NFS, SMB/CIFS), auto network replenishment (ANR)
Client	iVMS-4200, HikCentral Pro, Hik-Connect
Web Browser	IE 10 to 11, Chrome 57+, Firefox 52+, Safari 11+
Image	
Image Parameters Switch	Yes
Image Settings	Saturation, brightness, contrast, sharpness, gain, and white balance adjustable by client software or web browser
Day/Night Switch	Day, Night, Auto, Schedule
Wide Dynamic Range (WDR)	120 dB
SNR	> 52 dB
Defog	Digital Defog
Image Enhancement	BLC, HLC, 3D DNR

Privacy Mask	24 programmable polygon privacy masks, mask color or mosaic configurable
Regional Focus	Yes
Regional Exposure	Yes
Interface	
Ethernet Interface	1 RJ45 10 M/100 M self-adaptive Ethernet port
On-board Storage	Built-in memory card slot, support microSD/SDHC/SDXC card, up to 256 GB
Audio	1 input (line in), max. input amplitude: 2-2.4 vpp, input impedance: 1 K Ω \pm 10%; 1 output (line out), line level, output impedance: 600 Ω
Alarm	2 inputs, 2 outputs
Reset	Yes
Event	
Basic Event	Motion detection, video tampering alarm, exception, alarm input and output
Smart Event	line crossing detection, intrusion detection, region entrance detection, region exiting detection, unattended baggage detection, object removal detection, audio exception detection
Alarm Linkage	Upload to FTP/NAS/memory card, notify surveillance center, send email, trigger alarm output, trigger recording, and PTZ actions (such as preset, patrol scan, pattern scan)
Smart Tracking	Manual tracking, auto-tracking
Deep Learning Function	
Face Capture	Detects up to 5 faces simultaneously, Supports detecting, tracking, capturing, grading, selecting of face in motion, and outputs the best face picture
General	
Power	12 VDC, Max. 24 W; PoE (802.3at)
Dimension	\varnothing 169 mm \times 161 mm (\varnothing 6.65" \times 6.34")
Weight	Approx. 2.45 kg (5.40 lb.)
Operating Condition	-30 $^{\circ}$ C to 65 $^{\circ}$ C (-22 $^{\circ}$ F to 149 $^{\circ}$ F). Humidity 90% or less (non-condensing)
General Function	Mirror, password protection
Approval	
Protection	IP66 (IEC 60529-2013), TVS 6000V lightning protection, surge protection and voltage transient protection

▪ Available Model





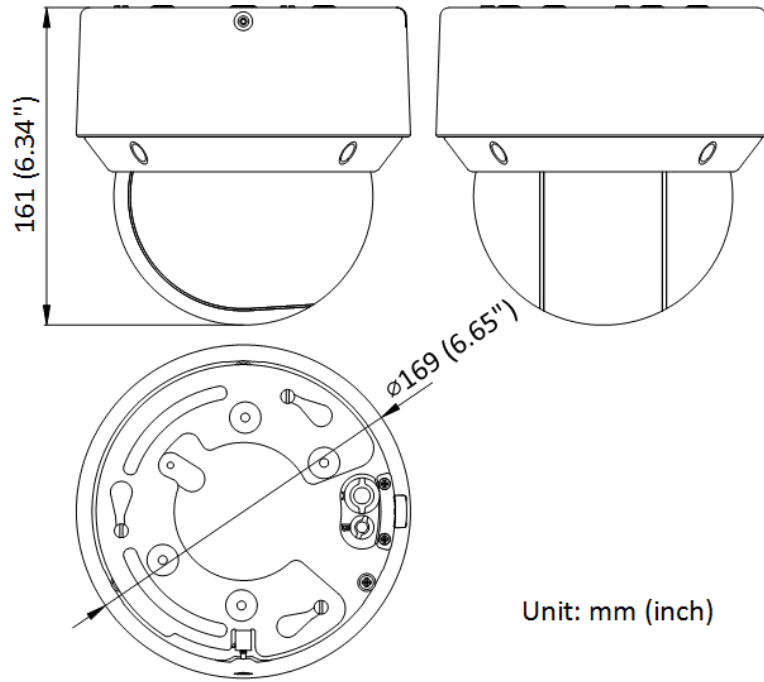

DS-2DE4A425IWG-E

▪ Dimension



▪ **Accessory**

▪ **Optional**

CPM-M Pendant Mount	CPM Pendant Mount	WMP-PV+ PC-DE4A Wall Mount	CPM-L Pendant Mount	CB-DE4A Junction Box
				
RCM-DE4A In-Ceiling Mount				
				

Headquarters

No.555 Qianmo Road, Binjiang District,
Hangzhou 310051, China
T +86-571-8807-5998
www.hikvision.com



Follow us on social media to get the latest product and solution information.

